

4

3

2

1

REVISIONS

REV	DESCRIPTION	DATE	APPROVED
A	Released	5/12/2009	

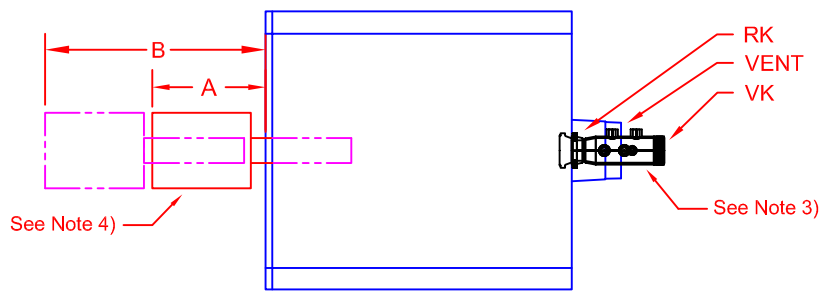

PLAN VIEW

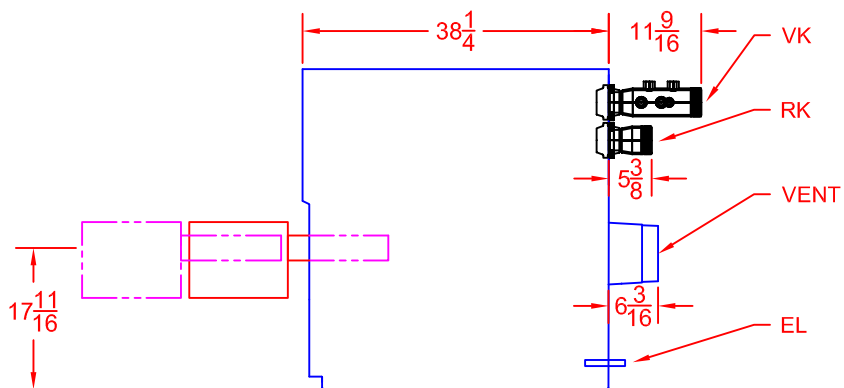

SIDE VIEW

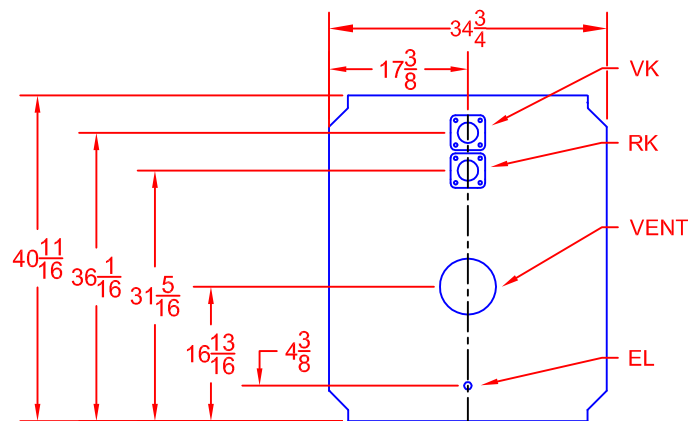

REAR VIEW

G315-5 (358 MBTH)

Oil

Riello	A	B	Power Flame	A	B	Beckett	A	B
F15	11 3/4	21 3/4	C1-0	30 7/8	34 1/8	CF500	11 1/2	16

Legend		
ABR.	Name	Size
VK	Supply	3
RK	Return	3
EL	Boiler Drain	3/4

NOTE 1. 'A' Dimension is to the back of the burner.
'B' Dimension is the extraction dimension.

- 2. All dimensions are in inches.
- 3. Manifold provided, field assembly required.
- 4. Burner shipped separately; field assembly required.

Bosch Thermotechnology Corp.
50 Wentworth Ave.
Londonderry, NH 03053
Phone: 603-552-1100

Tolerance
Fraction = ± 1/4"
x.x = ± 0.030
x.xx = ± 0.015
x.xxx = ± 0.005
(UNLESS OTHERWISE NOTED)

This drawing is the exclusive property of Bosch Thermotechnology Corporation, it may not be reproduced or given to third parties.

Drawn By:
M SPIRIDIGLOIZZI
Approved By:
J MILLS



Bosch Thermotechnology Corp.

DESCRIPTION
G315-5 BOILER BURNER SPECIFICATION

SIZE A	SCALE 1/2" = 1'	PART NO BTC 411006101	REV. A
DATE 4/15/2009		SHEET 1 of 1	

4

3

2

1

4

3

2

1

REVISIONS

REV	DESCRIPTION	DATE	APPROVED
A	Released	5/12/2009	

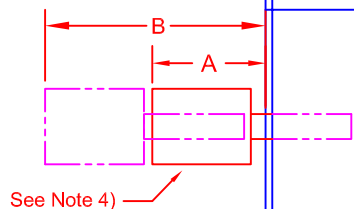

PLAN VIEW

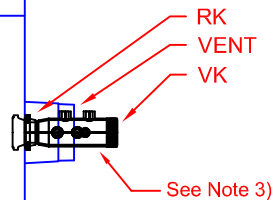

See Note 3)

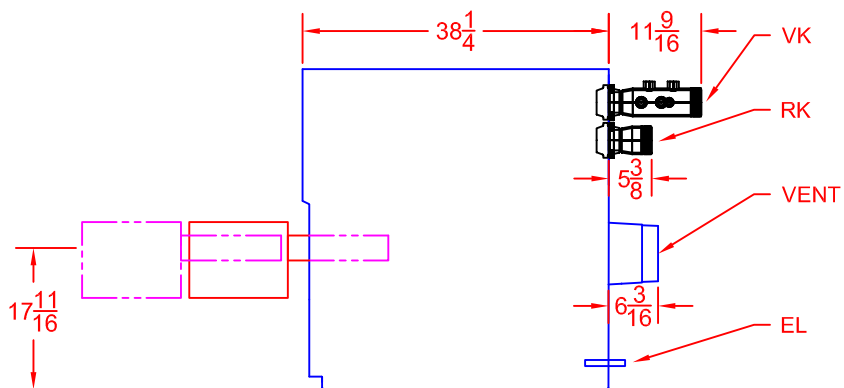

SIDE VIEW

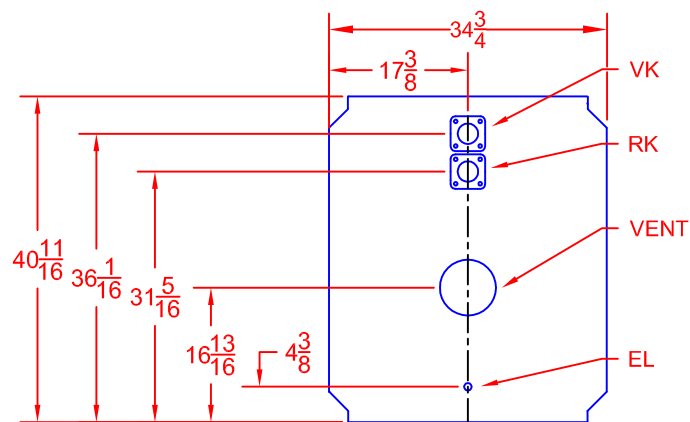

REAR VIEW

G315-5 (358 MBTH)

Gas

Riello	A	B	Power Flame	A	B	Beckett	A	B
40G900	15 1/4	20	J15A-10	22 1/4	25 1/4	CG10.2S	21	25 1/2
			C1-G-10	30 7/8	34 7/8			

Legend

ABR.	Name	Size
VK	Supply	3
RK	Return	3
EL	Boiler Drain	3/4

NOTE 1. 'A' Dimension is to the back of the burner.
'B' Dimension is the extraction dimension.

- All dimensions are in inches.
- Manifold provided, field assembly required.
- Burner shipped separately; field assembly required.

Bosch Thermotechnology Corp.
50 Wentworth Ave.
Londonderry, NH 03053
Phone: 603-552-1100

Tolerance

Fraction = $\pm \frac{1}{4}$ "
x.x = ± 0.030
x.xx = ± 0.015
x.xxx = ± 0.005

(UNLESS OTHERWISE NOTED)

This drawing is the exclusive property of Bosch Thermotechnology Corporation, it may not be reproduced or given to third parties.

Drawn By:
M SPIRIDIGLOZZI
Approved By:
J MILLS

Buderus

Bosch Group

Bosch Thermotechnology Corp.

DESCRIPTION
G315-5 BOILER BURNER SPECIFICATION

SIZE	SCALE	PART NO	REV.
A	1/2" = 1'	BTC 411006101	A
DATE 4/15/2009		SHEET 1 of 1	

4

3

2

1

4

3

2

1

REVISIONS

REV	DESCRIPTION	DATE	APPROVED
A	Released	5/12/2009	

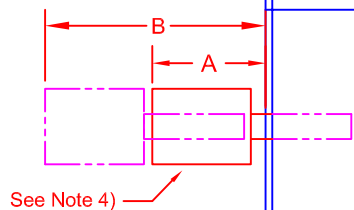

PLAN VIEW

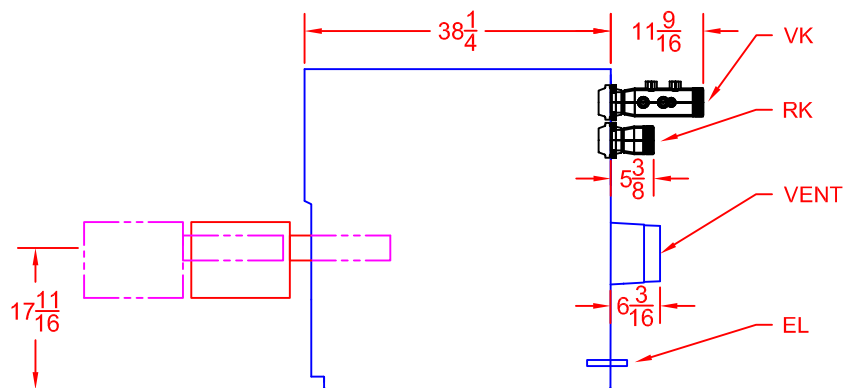
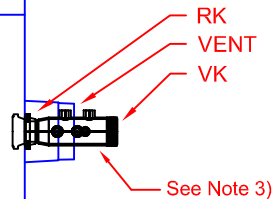

SIDE VIEW

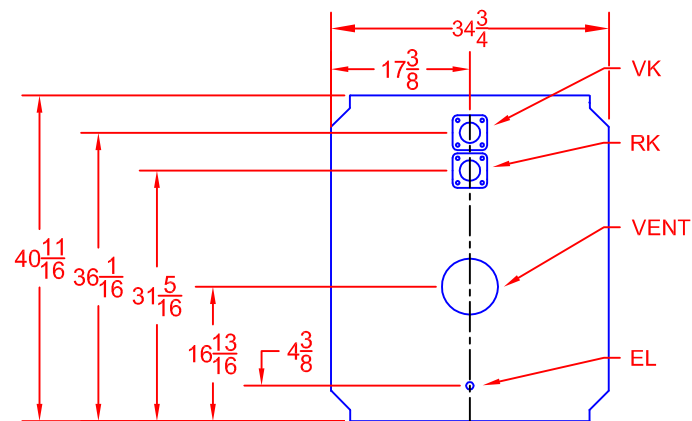

REAR VIEW

G315-5 (358 MBTH)

Combination

Power Flame	A	B
C1-GO-10	30 7/8	34 7/8

Legend

ABR.	Name	Size
VK	Supply	3
RK	Return	3
EL	Boiler Drain	3/4

NOTE 1. 'A' Dimension is to the back of the burner.
'B' Dimension is the extraction dimension.

- All dimensions are in inches.
- Manifold provided, field assembly required.
- Burner shipped separately; field assembly required.

Bosch Thermotechnology Corp.
50 Wentworth Ave.
Londonderry, NH 03053
Phone: 603-552-1100

Tolerance

Fraction = $\pm \frac{1}{4}$ "
x.x = ± 0.030
x.xx = ± 0.015
x.xxx = ± 0.005

(UNLESS OTHERWISE NOTED)

This drawing is the exclusive property of Bosch Thermotechnology Corporation, it may not be reproduced or given to third parties.

Drawn By:
M SPIRIDIGLOIZZI
Approved By:
J MILLS

Buderus

Bosch Group

Bosch Thermotechnology Corp.

DESCRIPTION
G315-5 BOILER BURNER SPECIFICATION

SIZE	SCALE	PART NO	REV.
A	1/2" = 1'	BTC 411006101	A

DATE 4/15/2009

SHEET 1 of 1

4

3

2

1

4 3 2 1

REVISIONS			
REV	DESCRIPTION	DATE	APPROVED
A	RELEASED	6/12/2009	

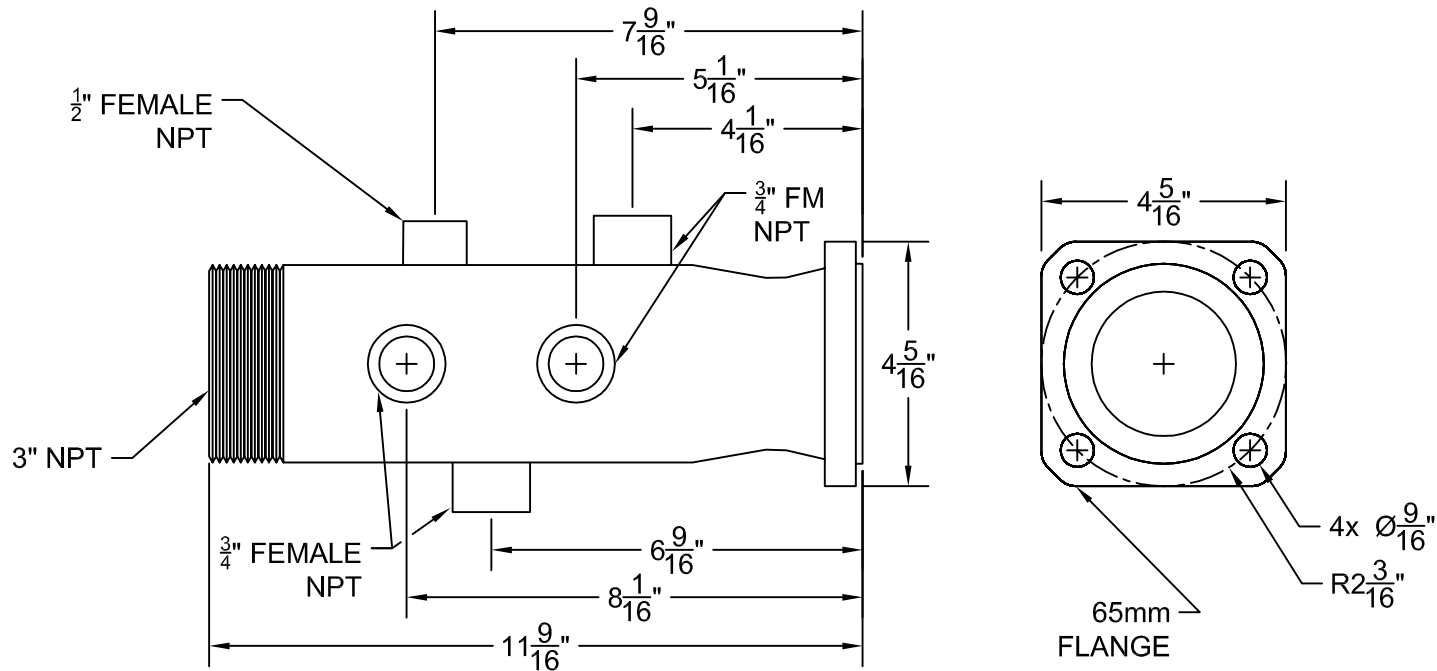

NOTE
 1. All dimensions are in inches.
 2. All pipe sizes are NPT.

Bosch Thermotechnology Corp.
 50 Wentworth Ave.
 Londonderry, NH 03053
 Phone: 603-552-1100

Tolerance
 Fraction = ± 1/4"
 x.x = ± 0.030
 x.xx = ± 0.015
 x.xxx = ± 0.005
 (UNLESS OTHERWISE NOTED)

This drawing is the exclusive property of Bosch Thermotechnology Corporation, it may not be reproduced or given to third parties.

Drawn By:
 M SPIRIDIGLOZZI

Approved By:
 J MILLS

Buderus		Bosch Thermotechnology Corp.	
Bosch Group		DESCRIPTION G315 SUPPLY MANIFOLD SPECIFICATION	
SIZE A	SCALE NTS	PART NO. BTC 411006111	REV. A
DATE 6/9/2009		SHEET 1 of 2	

4 3 2 1

4

3

2

1

REVISIONS

REV	DESCRIPTION	DATE	APPROVED
A	RELEASED	6/12/2009	

D

D

C

C

B

B

A

A

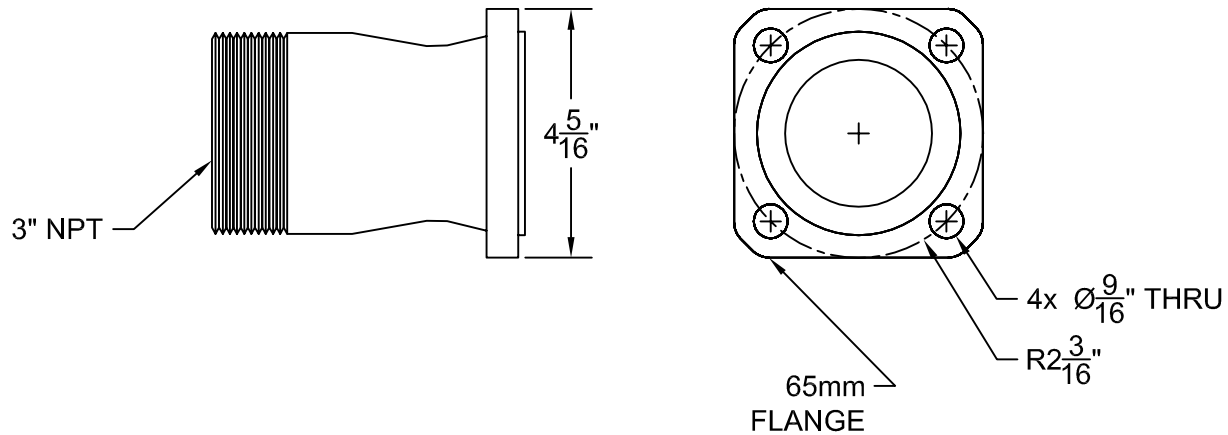

NOTE

- 1. All dimensions are in inches.
- 2. All pipe sizes are NPT.

Bosch Thermotechnology Corp.
 50 Wentworth Ave.
 Londonderry, NH 03053
 Phone: 603-552-1100

Tolerance
 Fraction = ± 1/4"
 x.x = ± 0.030
 x.xx = ± 0.015
 x.xxx = ± 0.005
 (UNLESS OTHERWISE NOTED)

This drawing is the exclusive property of Bosch Thermotechnology Corporation, it may not be reproduced or given to third parties.

Drawn By:
 M SPIRIDIGLOZZI
 Approved By:
 J MILLS



Bosch Thermotechnology Corp.

DESCRIPTION
 G315 RETURN MANIFOLD SPECIFICATION

SIZE A	SCALE NTS	PART NO. BTC 411006111	REV. A
DATE 6/9/2009		SHEET 1 of 2	

4

3

2

1